

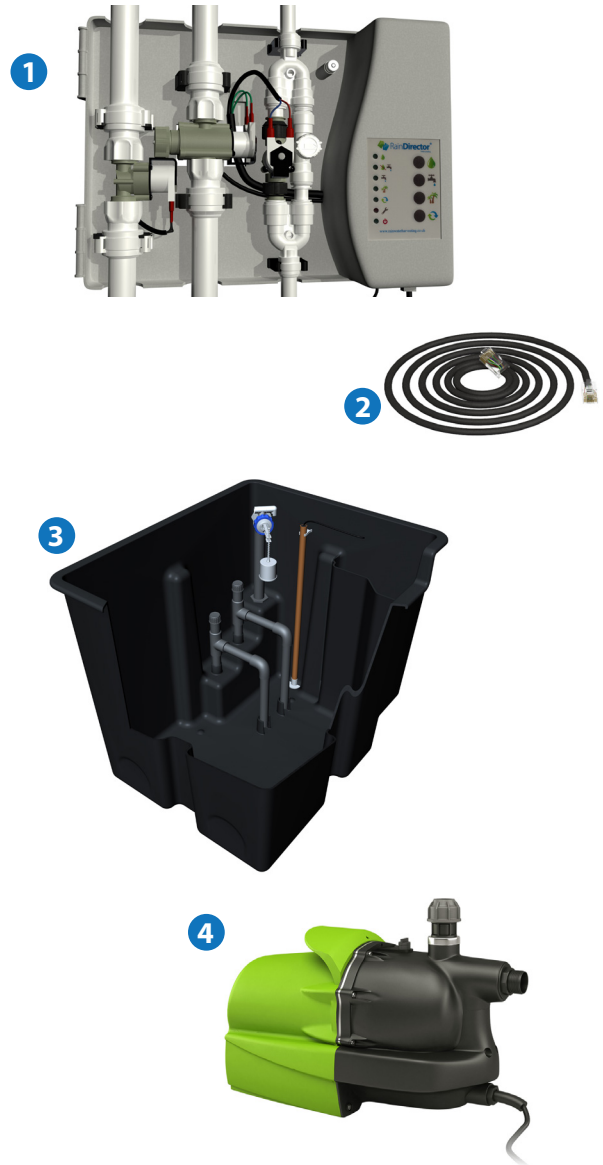

RainDirector®

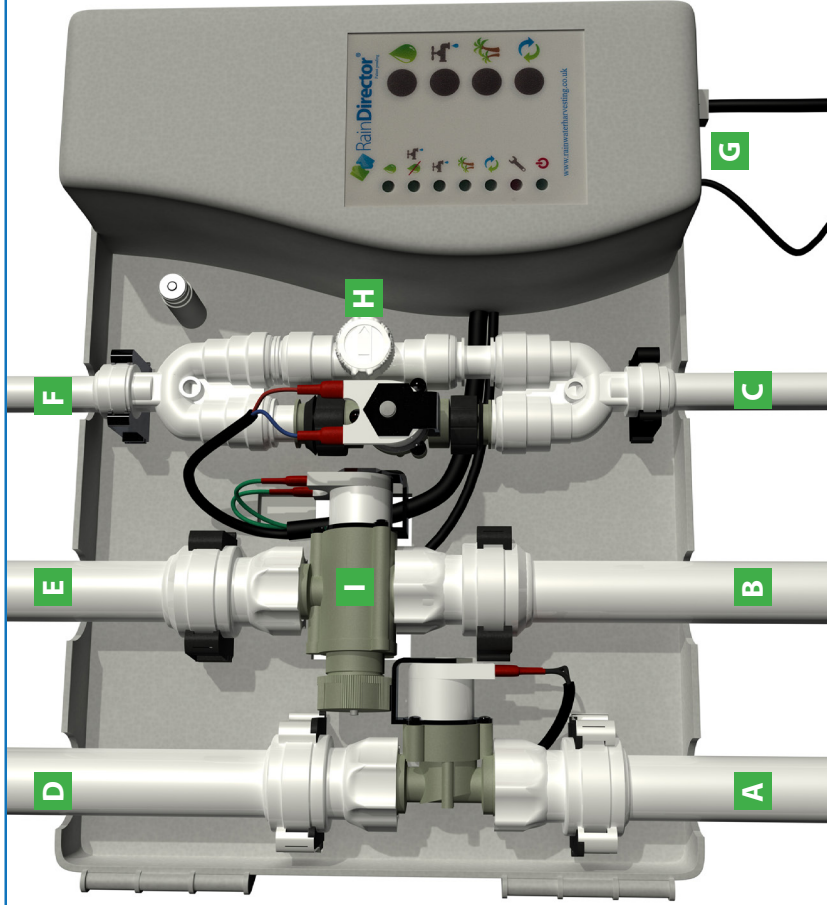

WHAT'S IN THE BOX	
1	Rain Director® control panel with mode indicators, programming buttons and control valves and 230 V AC to 12 V wall adapter. Control panel measures 380mm W x 270mm H x 95mm D.
2	Cat 5 cable to connect junction box on header tank to underside of control panel. Do Not Cut!
3	Smart header tank for roof space, including level sensor bar, Cat5 connection box and overflow tower. The 100 litre tank measures 600mm W x 490mm H x 500mm D.
4	Mains electric submersible pump (must be pressure-sensitive and equipped with non-return valve).



KEY TO THE CONTROL PANEL AND PIPE DIAMETERS:

- A** Refresh outlet to underground tank - 22mm.
- B** Rainwater inlet from pump - 22mm.
- C** Mains water inlet - 15mm.
- D** Refresh inlet from services - 22mm.
- E** Refresh outlet to header tank - 22mm.
- F** Mains water outlet to header tank - 15mm.
- G** 12v power from wall adapter and Cat 5 cable to header tank.
- H** Mains water manual bypass valve.
- I** Rainwater valve and removable filter.

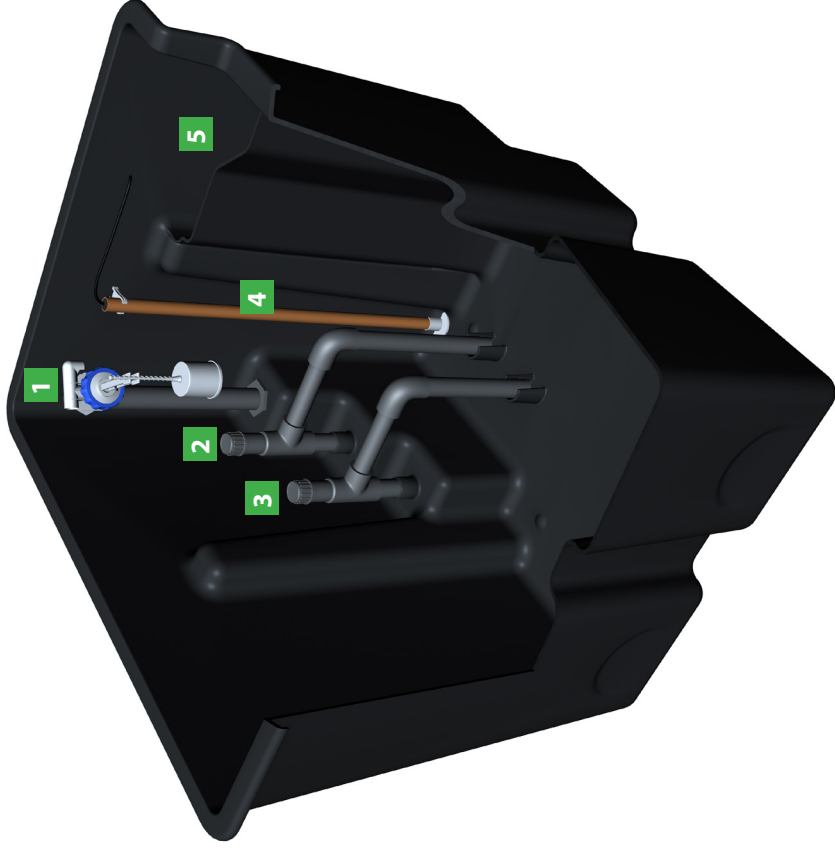
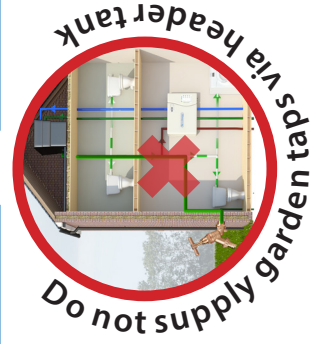

KEY TO THE SMART HEADER TANK AND PIPES

- 1** Mains water inlet from control panel - 15mm.
- 2** Rainwater inlet from control panel - 22mm.
- 3** Services outlet - 22mm.
- 4** Tank level sensor bar.
- 5** Overflow straight out of the house - 40mm.

ESSENTIAL NOTES

Do not install the Rain Director® in any way other than as given here and do not disassemble Rain Director® components for installation. Incorrect installation invalidates all warranties.

- Do not get any dirt into the underground tank, header tank or pipes: risk of blockage in the solenoid valves.
- Do not cut or modify the supplied CAT 5 cable. Only use the cable supplied by Rainwater Harvesting Ltd. Longer cables are available upon request.
- The header tank must be fitted at least 1.2 metres above the control panel and highest toilet.
- The header tank must be fitted a minimum of 5 metres above the washing machine to provide sufficient pressure.
- Run all garden taps **directly from the pump** and not from the header tank.
- Install all pipes and equipment where protected from frost.
- All pipework must have a degree of fall.

Locate the control panel where the rainwater enters the building on a wall in a frost protected area, (at least 1.2m below header tank)

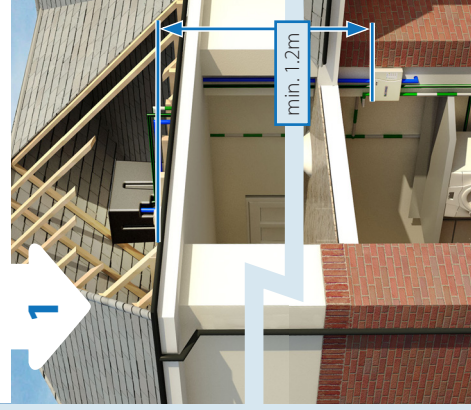

The header tank must be accessible for maintenance. Ensure the lid is secure and kept in place during installation. **Keep dirt out!** Insulate if required.



Take all pipes that are to be connected to the control panel and flush thoroughly. Ensure no dirt will enter the valves on the control panel.



Connect the refresh outlet pipe **(A)** back to the rainwater underground tank, rainwater inlet pipe **(B)** back to the pump, and mains water inlet **(C)** (via a shut-off valve) to mains water.

Connect any part of the 22mm gravity feed piping that's above the control panel for services, running from the services outlet **(3)** of the header tank, to the refresh inlet **(D)**.

Connect the rainwater outlet **(E)** to the header tank **(2)** and mains water outlet **(F)** to the header tank **(1)**.

Use pipe fittings which will permit removal of solenoids.

Connect the mains water outlet from the control panel (F) to the header tank mains water inlet (1) using 1/2 inch BSP.



Connect the rainwater outlet from the control panel (E) to the header tank rainwater inlet (2). Connect the gravity feed pipe to the header tank services outlet (3). Both designed to accept a 22mm push-fit fitting.

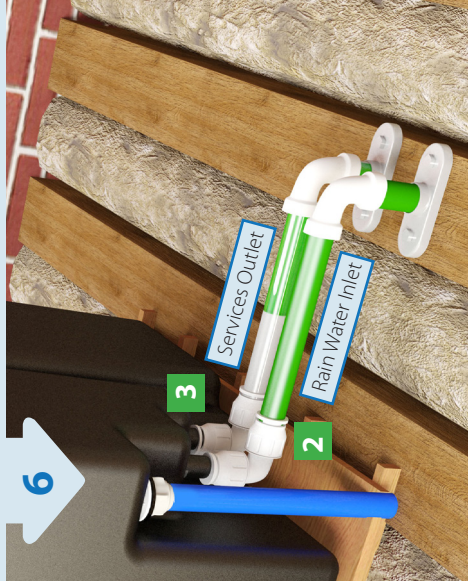

The overflow (6) must run straight out of the house without obstruction, bends, or decreasing pipe diameter. Use 40mm waste pipe elbow, either solvent or compression fitting.



Use the quarter turn valve on the control panel (H) to partially fill the header tank. Check thoroughly for leaks at all connections.

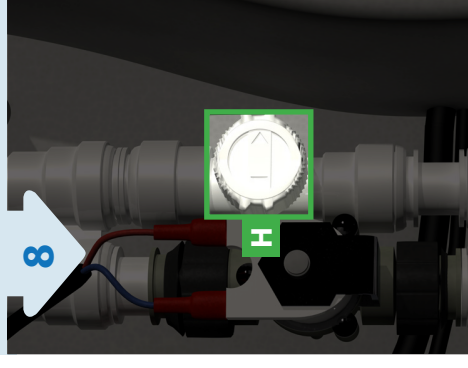

Fully fill the header tank and unscrew services cap. Wait for all air to leave the system to eliminate airlocks then replace cap ensuring that the black washer under the cap is replaced.

Turn the quarter turn valve (H) back off.



Connect the Cat 5 cable to the connector (G) at the control panel and similar connector at the header tank.



Connect the power (G) to the control panel and the commissioning sequence will begin. While commissioning, different light sequences will flash. This process may take up to twenty minutes.

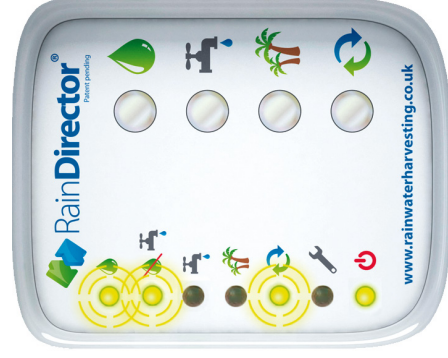

Commissioning has finished once the rainwater light and power light are on. The system is now in rain mode.



PLUMBING SCHEMATIC

WIRING SCHEMATIC

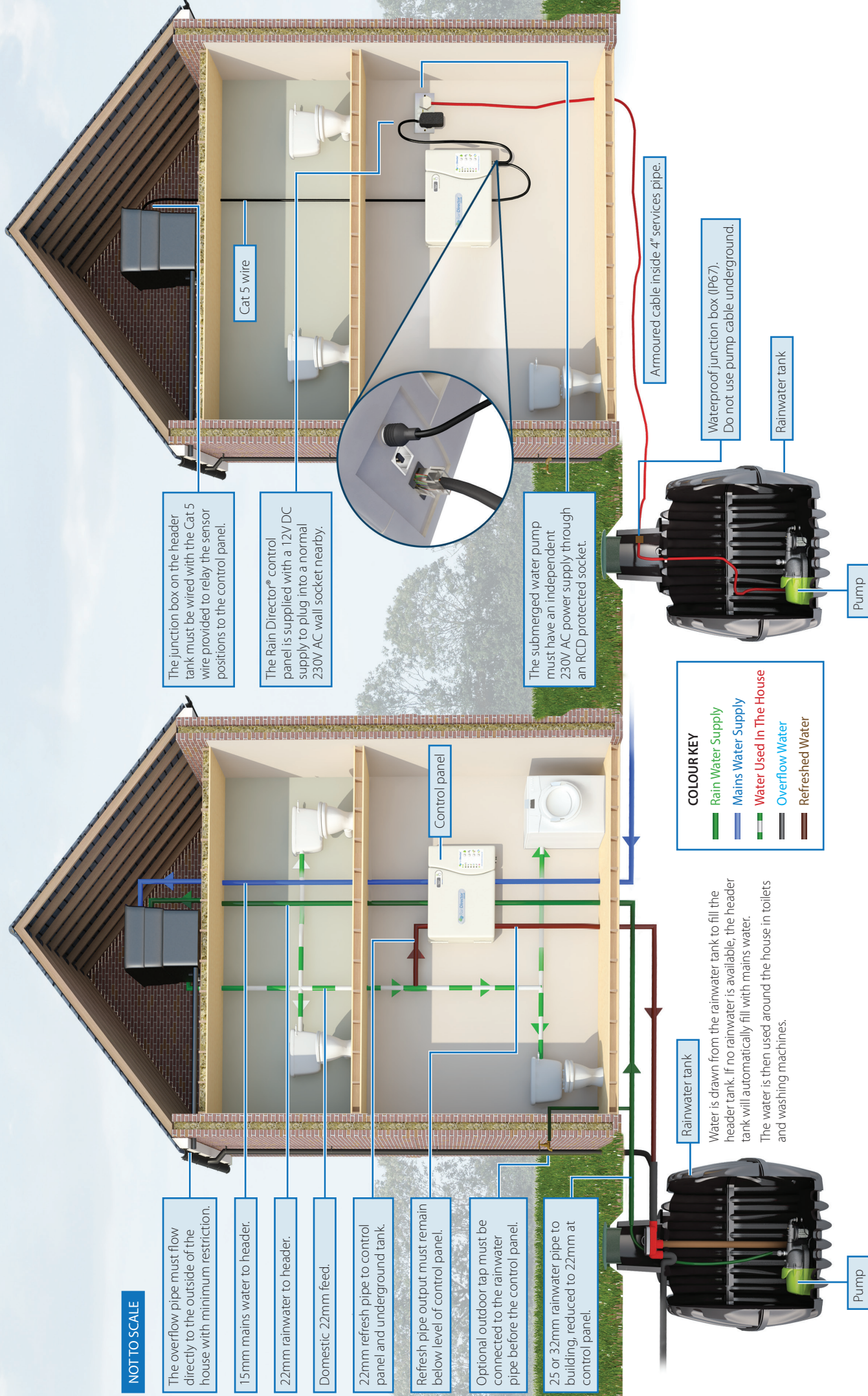



- » **Rain Mode (Normal Mode):** System will use rainwater within the home. If rainwater is not available in the underground storage tank, the system will automatically register and switch over to mains water.
- » **Mains Water Mode:** Press during a dry period or hose pipe ban to run internal appliances on mains water and conserve rainwater for garden use.
- » **Holiday Mode:** If leaving the home for a prolonged period of time (over 1 week) press the holiday button to empty the header tank and refill with treated mains water. This prevents water quality issues. When the system is used again it will automatically revert back to Rain mode. It may be sensible to flush each toilet twice to leave treated water in the cistern and bowl.
- » **Refresh Function:** If no activity is registered the system will automatically refresh the water within the smart header tank every 3 days. The system will drain the smart header tank back to the underground tank, and refill the smart header tank with fresh rainwater. This guarantees high quality water with no risk of discolouration or smells. Although the system refreshes automatically, the user can press the button to refresh the system at any point.

Technical Support Line 01733 405 111 (opt. 2)

Problem	Probable cause	Remedy
Flashing red spanner light during initial power up/commission	Sensor bar is not connected or wiring fault	Check connections of the Cat 5, making sure it's plugged in at the Rain Director and header tank.
Solid red spanner light during commissioning	Filling fault	Check Rainwater and mains water are available to the system, repeat process 9 to remove airlocks from the system. Clear solenoid valves (contact supplier).
Mains water or refresh solenoid constantly open	Solenoid blocked open	Clear solenoid (contact supplier).
Mains filling light showing during normal mode	Rainwater tank empty, pump not functioning	Check rainwater level in underground tank. If level high refer to pump guide.
Mains filling light showing despite rainwater working and filling first	Slow fill causing commissioning time-out	Check/clean rain solenoid (contact supplier) recommission system (refer to point 11).
No lights on circuit board	No power reaching PCB board	Check power to the Control panel, contact supplier for further advice if problem persists.
Toilets not filling/system airlocked	Water supply less than demand	Check plumbing for obstructions, remove booster pumps, REMOVE GARDEN TAPS DIRECT FROM HEADER TANK, repeat.
Header tank overflow to waste	Rain or Mains Solenoid blocked open	Clear solenoid (contact supplier).
Power cut in the home	Pump & control panel not functioning	The system will auto fill with mains water. If this fails, use the quarter turn valve (H) to bypass the system and refill the header tank with mains water.
Poor rainwater flow into the header tank	Rain filter blocked	Check the filter on the rain feed valve (I) and remove dirt (turn off the pump first). Repeat after a week.

All components have been designed to comply with the UK Building Regulations and WRAS (Water Regulations Advisory Scheme). WRAS Approval No. 1505033



CE RainWater Harvesting Ltd. certifies that the Rain Director® is compliant with the safety requirements of the Machine Directive 89/392/EC and amendments, of the Low Voltage Directive 73/23/EC and in the Electromagnetic Compatibility Directive 89/336/EC and amendments. The materials and manufacturing of this product are guaranteed for 2 years from the date of purchase if the installation instructions are complied with. In the event of an apparent fault, the retailer or installer should be contacted first. RainWater Harvesting Ltd. declines responsibility for incidents or damage caused by negligence or by ignoring these instructions. **Installation according to this installation manual is required for manufacturers' warranties to be valid.**



All rights reserved by RainWater Harvesting Limited, © 2014. The term Rain Director® is proprietary and protected by trade mark legislation. UK, European and Worldwide patents for the Rain Director® and certain features applied for. No part of this document can be reproduced without our permission. Phone 01733 405111. Email: info@rainwaterharvesting.co.uk. www.rainwaterharvesting.co.uk